

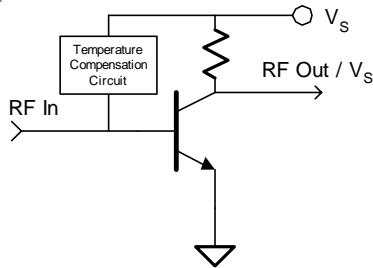

Product Description

The SGL-0263 is a high performance SiGe HBT MMIC low noise amplifier featuring 1 micron emitters with F_T up to 50 GHz. This device has an internal temperature compensation circuit permitting operation directly from supply voltages as low as 2.5V. The SGL-0263 has been characterized at $V_d = 3V$ for low power and 4V for medium power applications. Only 2 DC-blocking capacitors, 2 input matching components, a bias resistor, and an optional RF choke are required for operation from 1400-2500 MHz.

The matte tin finish on Sirenza's lead-free "Z" package is applied using a post annealing process to mitigate tin whisker formation and is RoHS compliant per EU Directive 2002/95. The package body is manufactured with green molding compounds that contain no antimony trioxide or halogenated fire retardants.



SGL-0263

SGL-0263Z  RoHS Compliant & Green Package

1400 - 2500 MHz Silicon Germanium Cascadable Low Noise Amplifier



Product Features

- Available in Lead Free, RoHS Compliant green package (Z Suffix)
- High Input / Output Intercept
- Low Noise Figure: 1.3dB typ. at 1900 MHz
- Low Power Consumption
- Single Voltage Supply Operation
- Internal Temperature Compensation

Applications

- Receivers, GPS, RFID
- Cellular, Fixed Wireless, Land Mobile

Symbol	Parameter	Freq. (MHz)	Min. ($V_s=3V$)	Typ. ($V_s=3V$)	Max. ($V_s=3V$)	Typ. ($V_s=4V$)	Units
G	Small Signal Gain	1900 2100 2400	12.1	13.4 12.5 10.8	14.7	13.8 12.9 11.3	dB
P_{1dB}	Output Power at 1dB Compression	1900 2100 2400	3.5	5.5 6.8 7.9		11.4 12.3 12.8	dBm
IIP_3	Input Third Order Intercept Point Tone Spacing = 1 MHz P_{out} per tone = -13dBm	1900 2100 2400	7.5	9.5 13.5 15.5		15.1 16.8 18.4	dBm
NF	Noise Figure, $Z_s = 50$ Ohms	1900 2100 2400		1.3 1.5 2.0	1.7	1.9 2.1 2.8	dB
IRL	Input Return Loss	1900	10.0	13.3		21.9	dB
ORL	Output Return Loss	1900	10.0	12.9		17.4	dB
$ S_{12} $	Reverse Isolation	1900		20.7		21.0	dB
I_b	Device Current		9.0	12.5	15	23	mA
$R_{TH(j-l)}$	Thermal Resistance (junction to lead)			255			$^{\circ}C/W$
Test Conditions: 1400-2500 MHz Application Circuit $T_{LEAD} = 25^{\circ}C$ $Z_0 = Z_L = 50$ Ohms							

The information provided herein is believed to be reliable at press time. Sirenza Microdevices assumes no responsibility for inaccuracies or omissions. Sirenza Microdevices assumes no responsibility for the use of this information, and all such information shall be entirely at the user's own risk. Prices and specifications are subject to change without notice. No patent rights or licenses to any of the circuits described herein are implied or granted to any third party. Sirenza Microdevices does not authorize or warrant any Sirenza Microdevices product for use in life-support devices and/or systems. Copyright 2005 Sirenza Microdevices, Inc.. All worldwide rights reserved.

Typical RF Performance Over Lead Temperature at 3 V and 4 V -- 1400-2500 MHz Evaluation Board

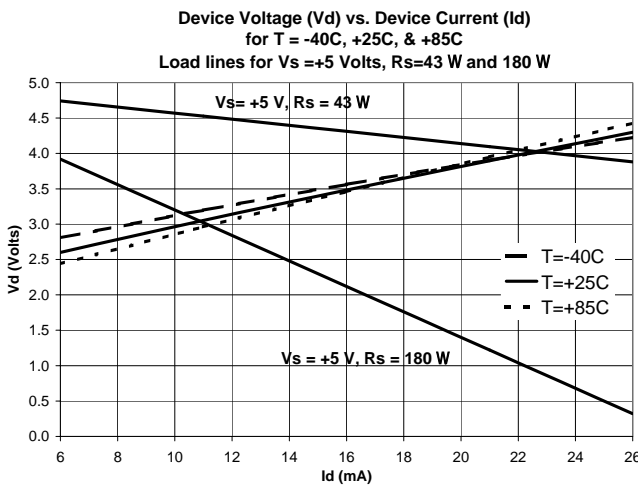
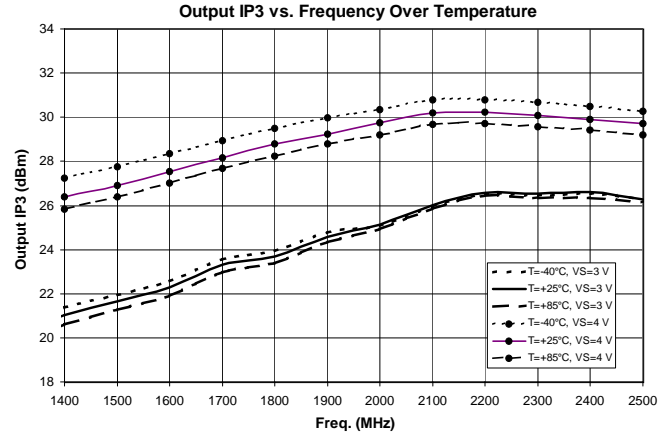
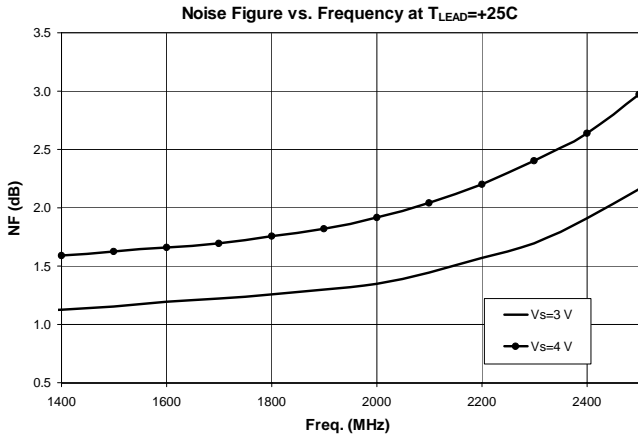
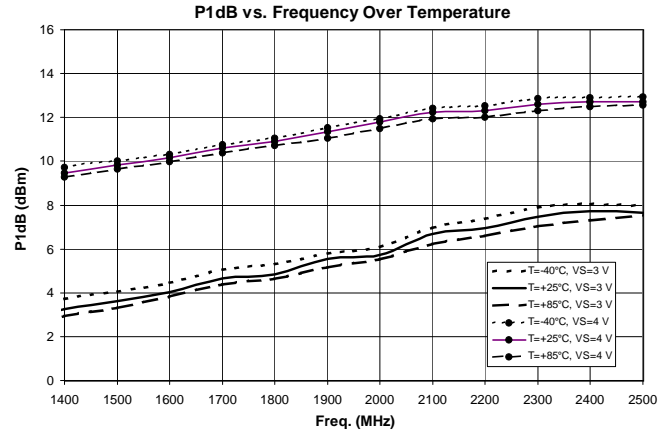
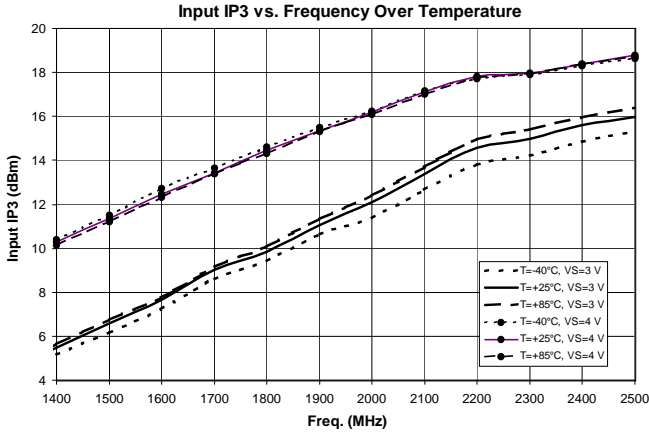

Absolute Maximum Ratings

Parameter	Absolute Limit
Max. Device Current (I _D)	45 mA
Max. Device Voltage (V _S)	5 V
Max. RF Input Power	+10 dBm
Max. Junction Temp. (T _J)	+150°C
Operating Temp. Range (T _{LEAD})	-40°C to +85°C
Max. Storage Temp.	+150°C

Operation of this device beyond any one of these limits may cause permanent damage. For reliable continuous operation, the device voltage and current must not exceed the maximum operating values specified in the table on page one.

Bias conditions should also satisfy the following expression:

$$I_D V_D < (T_J - T_{LEAD}) / R_{TH} \text{ } ^\circ\text{C/W}$$

Typical RF Performance at $V_s = 3\text{ V}$ -- 1400-2500 MHz Evaluation Board -- $T_{LEAD} = +25^\circ\text{C}$

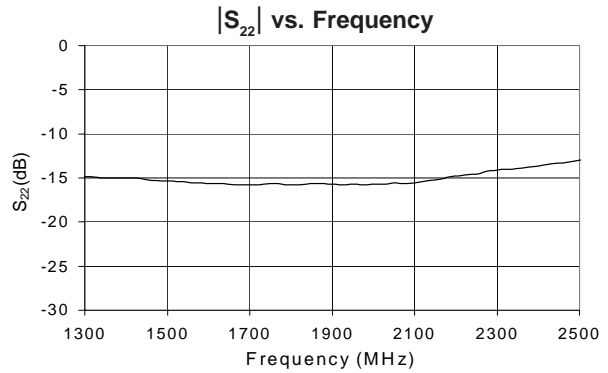
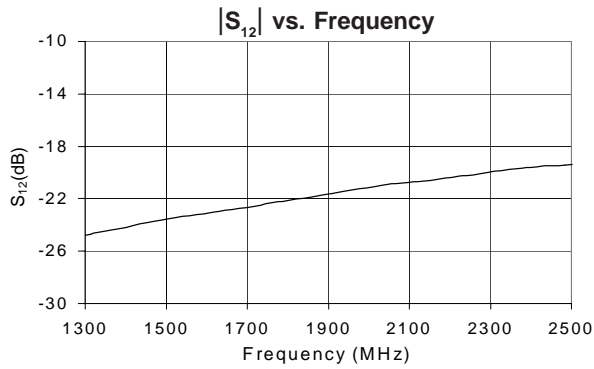
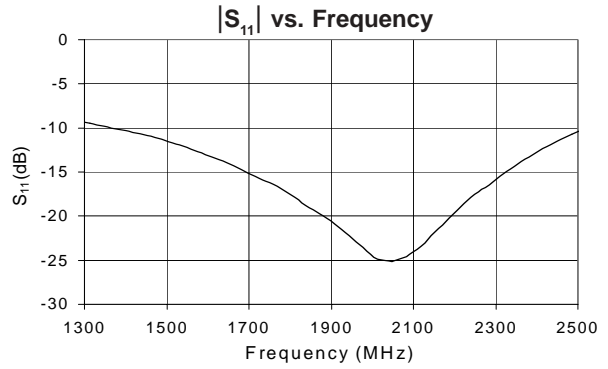
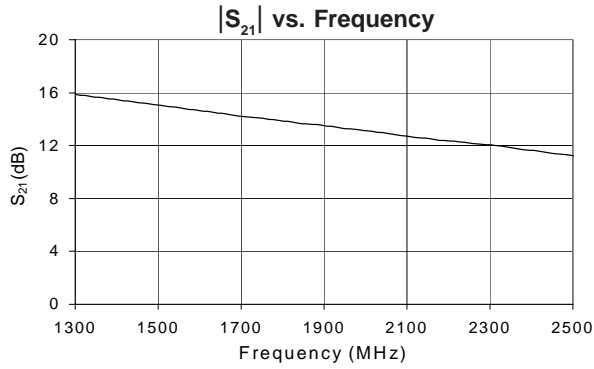

Typical RF Performance at $V_s = 4\text{ V}$ -- 1400-2500 MHz Evaluation Board -- $T_{LEAD} = +25^\circ\text{C}$

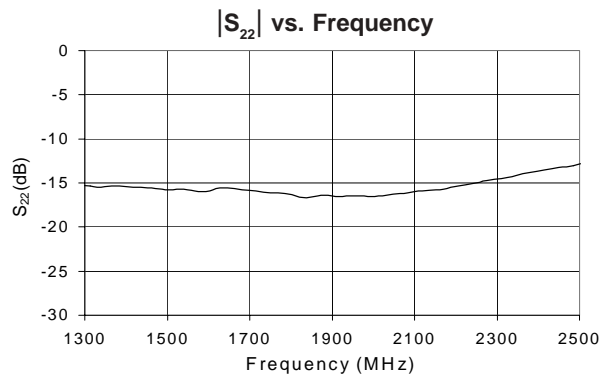
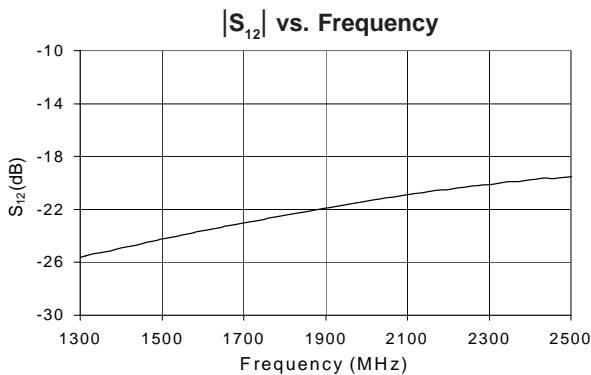
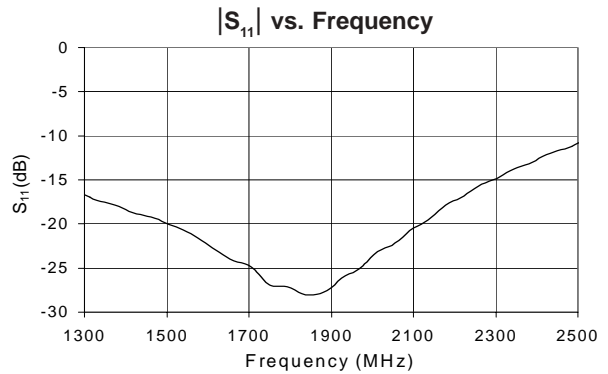
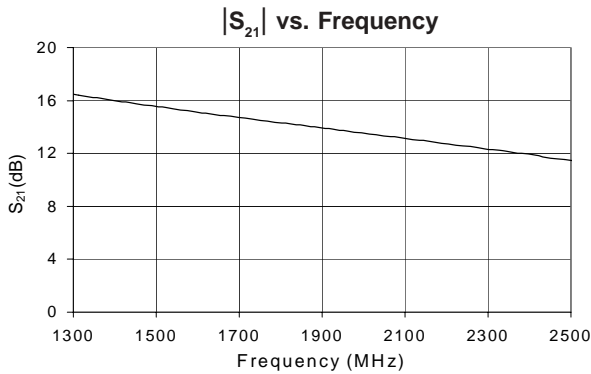

NOTE: Full S-parameter data available at www.sirenza.com

1400-2500 MHz Application Circuit

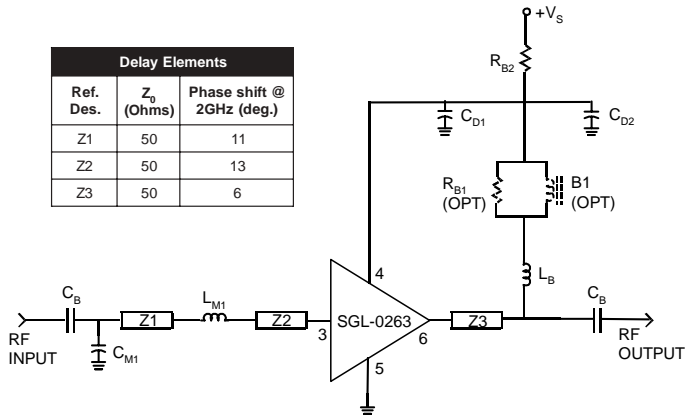

1400-2500 MHz Evaluation Circuit Board

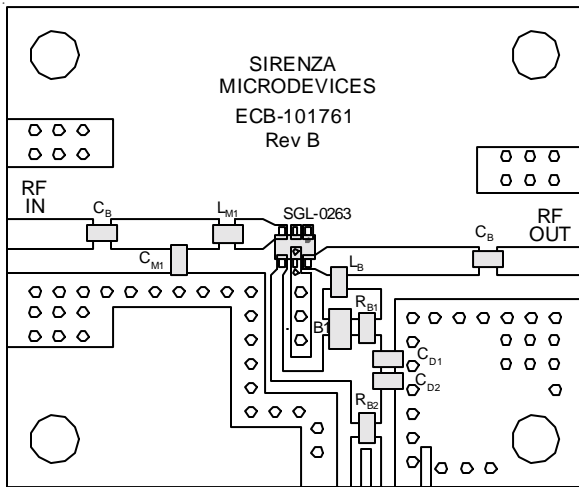

Note: Circuit board dielectric material is GETEK,ML200C

Application Circuit Element Values

Reference Designator	Value	Manufacturer & Part No.
L _B	27 nH	TOKO LL1608-FS27NJ
L _{M1}	1.2 nH	TOKO LL1608-FS1R2NJ
B1 ¹	1500 Ohms @100 MHz Ferrite Bead	FAIR-RITE 2508051527y0
C _B , C _{D1}	0.1 uF	SAMSUNG CL10B103KBNC
C _{D2}	22 pF	ROHM MCH185AA220DJK
C _{M1}	1.0 pF	ROHM MCH185A1R0CK
R _{B1} ¹	47 Ohms	PHILLIPS 9C06031A47R0 JL HFT
R _{B2} ²	0 Ohms	PHILLIPS 9C06031A0R00 JL HFT

Notes:

- B1 and R_{B1} provide improved K-factor but are optional.
- R_{B2} may be introduced as a voltage dropping resistor for use with supply voltages greater than the desired device bias voltage.

Device Pin Out Guide

Pin #	Function	Description
1	N/C	No electrical connection. Provide an isolated (un-grounded) solder pad for mounting integrity.
3	RF IN	RF input pin. This pin requires the use of an external DC blocking capacitor chosen for the frequency of operation.
4	DC BIAS	Voltage supply connection. Bypass with suitable capacitors.
2, 5	Ground	Connection to ground. Provide via holes as close to the device ground leads as possible to reduce ground inductance and achieve optimum RF performance.
6	RF OUT/BIAS	RF output and voltage supply. DC voltage is present on this pin, therefore a DC blocking capacitor is necessary for proper operation.

Part Identification Marking & Pin Out

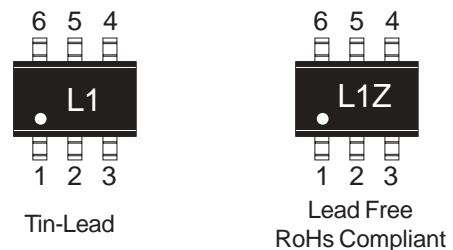

Reliability & Qualification Information

Parameter	Rating
ESD Rating - Human Body Model (HBM)	Class 1A
Moisture Sensitivity Level	MSL 1

The product qualification report may be downloaded at www.sirenza.com



Caution: ESD sensitive
Appropriate precautions in handling, packaging and testing devices must be observed.

Part Ordering Information

Part Number	Package / Lead Composition	Reel Size	Devices / Reel
SGL-0263	Tin-Lead	7"	3000
SGL-0263Z	Lead Free, RoHs Compliant	7"	3000

